



**VOLUME
GRAPHICS**

Enabling better products



VGSTUDIO MAX

High-End Industrial CT Software

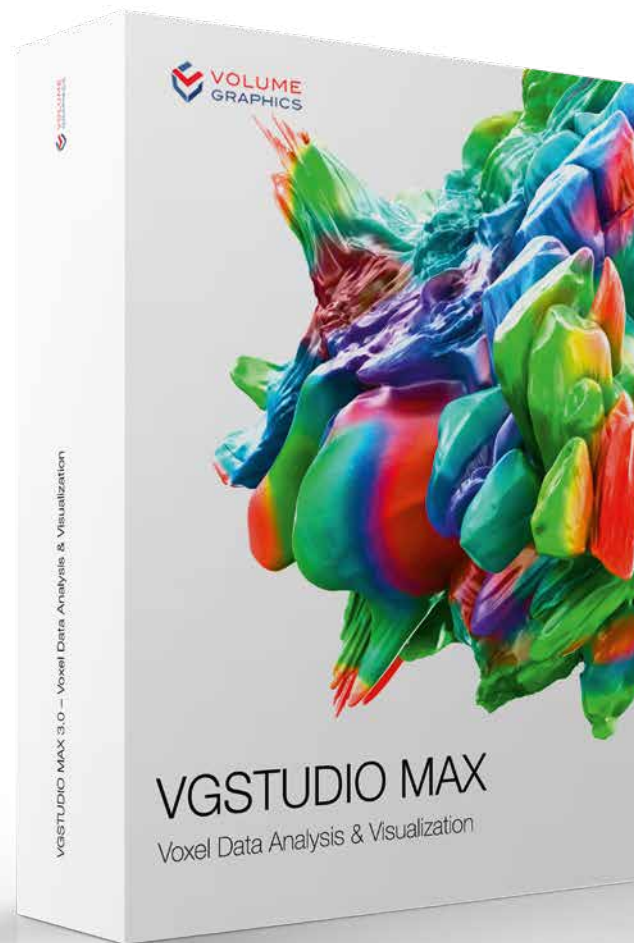

VGSTUDIO MAX

High-End Software for CT Data

VGSTUDIO MAX is the high-end software for the analysis and visualization of industrial computed tomography (CT) data. Innovative companies not only use VGSTUDIO MAX in non-destructive testing, but also increasingly integrate it into their future-oriented development and production solutions.

Areas of Application

- > **Measurements** on even the most difficult-to-access surfaces of a component (Coordinate Measurement Module)
- > **Non-destructive defect discovery** in castings, including prediction of pore cuts (Porosity/Inclusion Analysis Module)
- > **Defect analysis** according to specifications P 201 and P 202 (Enhanced Porosity/Inclusion Analysis Module)
- > **Comparison of manufactured parts** with CAD data, mesh data (.stl), or other voxel data (Nominal/Actual Comparison Module)
- > **Wall thickness analysis:** localization of areas with an insufficient or excessive wall thickness or gap width (Wall Thickness Analysis Module)
- > **Automation** through the modular use of macros in different contexts
- > **Determination of cell structures** in porous foams and filter materials (Foam Structure Analysis Module)
- > **Calculation of fiber orientations** and other relevant parameters in composite materials (Fiber Composite Material Analysis Module)
- > **Virtual stress tests** for the non-destructive simulation of mechanical stress directly on CT data (Structural Mechanics Simulation Module)
- > **Flow and diffusion experiments**, e.g., on CT scans of porous materials or composite materials (Transport Phenomena Module)
- > **Reconstruction** of three-dimensional volume data sets using images taken by a CT scanner (CT Reconstruction Module)

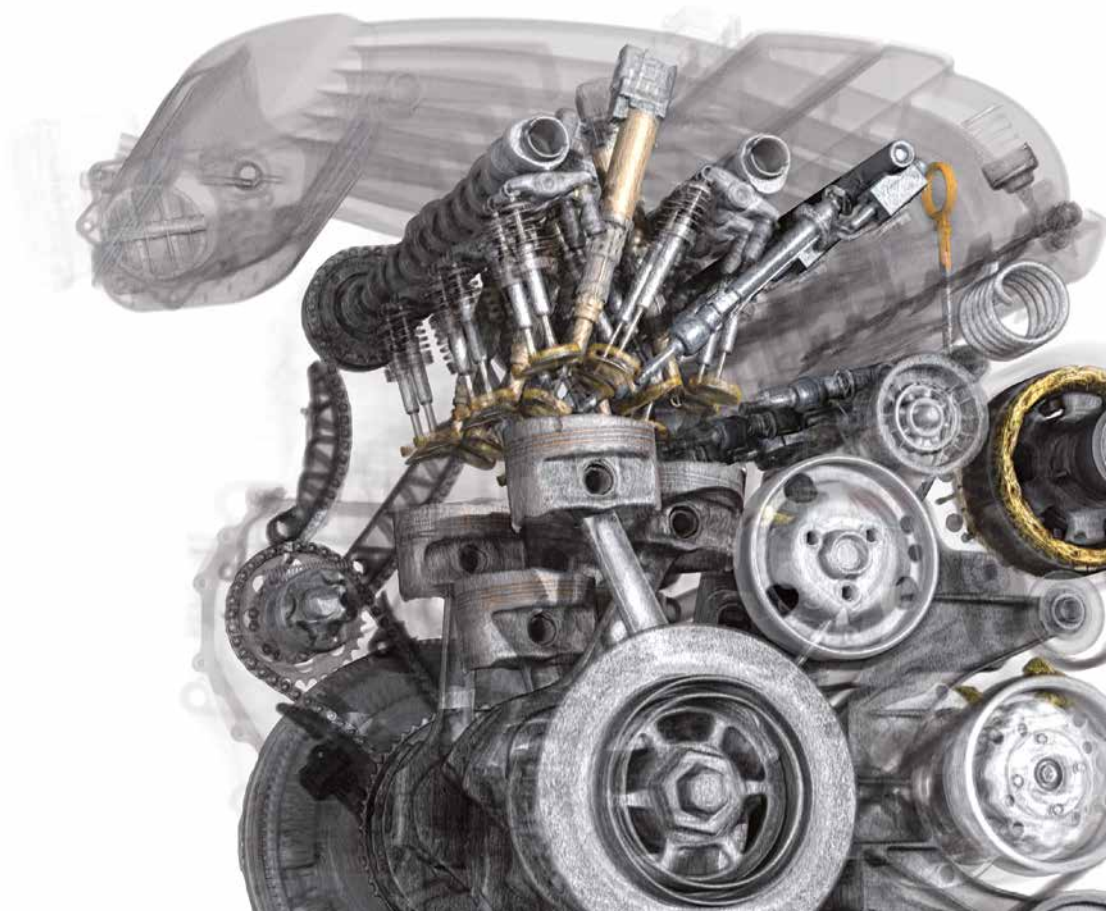



Working with VGSTUDIO MAX

- > **Determine surfaces with subvoxel accuracy** for the highest precision and smallest details (Coordinate Measurement Module).
- > **Work natively with voxel, point cloud, mesh, and CAD data.**
- > **Import native CAD files** for analyses and segmentation tasks (CAD Import Module).
- > **Use additional part information from PMI data** for efficient measurement plan creation (CAD Import with PMI Module).
- > **Quickly segment** volume data sets into individual parts or regions.
- > **Easily 'unroll' cylindrical objects**, flatten bent surfaces, and combine consecutive slices.
- > **Combine analyses**, e.g., to classify a defect according to its size in relation to the local wall thickness.

Efficiency

- > **Optimized for modern hardware** with SSD and SSD RAID storage and multiple GPUs
- > **Unload/reload data function for gray values:** Work with high-resolution CT data sets on less powerful PCs and easily transfer these projects. Gray-value-based analysis results are preserved.

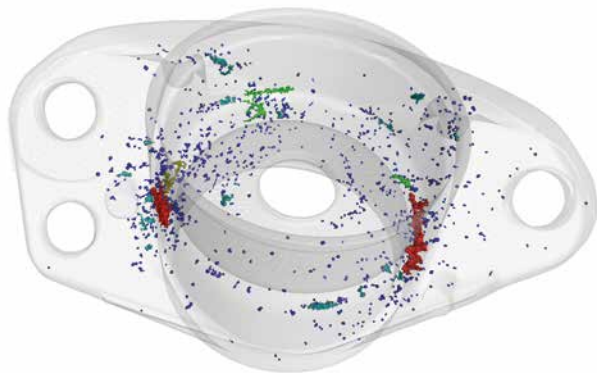

Volume

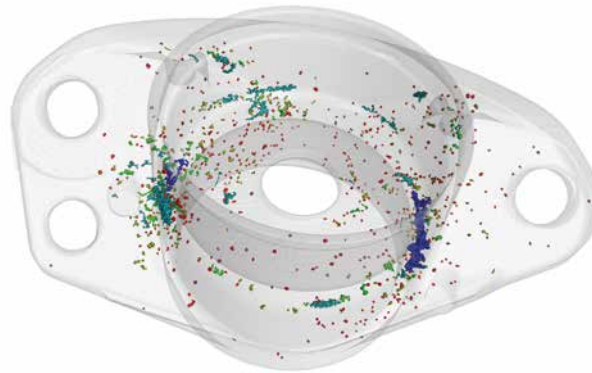

Sphericity

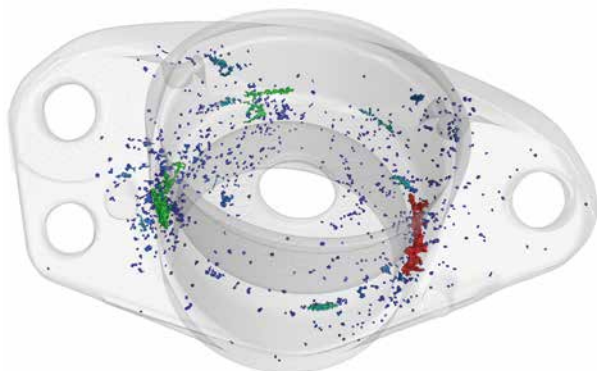

Diameter

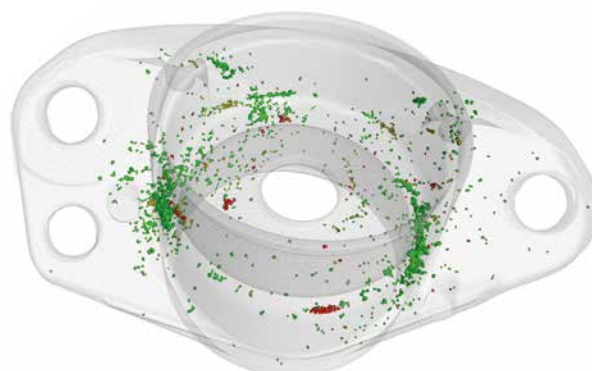

Distance to Surface

Use active columns to quickly switch between parameters for color-coding your analysis results.

User Interface

- > **Dark theme** for working with gray value images
- > **Bright theme** for measurement tasks
- > **3D rotation options** for better usability

Data Integrity and Safety Features

- > **Protection of raw data** against unwanted exchanges and manipulations
- > **Detection of simultaneous access** to a project file
- > **Merging of all files, folders, and source data** into a single file

Active Columns

- > **Quickly and easily switch between parameters for color-coding analysis results.**
- > For example, switch between visualizing a defect by its volume and its diameter with a click of the mouse.

Instruments

- > **For the simple measuring of distances, gray values, and angles**
- > Support macros and templates
- > Support tolerances



The cylindrical surface of a bottleneck has been unrolled to be viewed in a 'flattened' slice image.

Work with Bent Structures

- > **Unroll objects** and then scroll into the object slice by slice.
- > **Level a bent surface**, segment the leveled surface, and then transfer the segmentation back onto the bent surface.
- > **Combine consecutive slices** into a single 2D view to have all information in these slices visible at a glance.

Bookmarks

- > **Save bookmarks, including 3D and 2D views, clippings, selected coordinate systems, and rendering settings.**
- > Export and import bookmarks, even within macros.
- > Apply bookmarks to different data sets.

Supported 3D Formats

- > **Work natively with voxel, point cloud, mesh, and CAD data.**
- > Benefit from less measurement uncertainty, since the fitting of geometry elements is optimized for each supported data type (voxel, CAD, mesh, and point cloud data).
- > Repair and optimize corrupt CAD and mesh data during import.
- > Convert CAD or mesh data to voxel, voxel to mesh, or point cloud to mesh.
- > Create Regions of Interest (ROI) on CAD or mesh data and then use them for nominal/actual comparisons and wall thickness analyses.
- > Create ROI templates on the CAD model – before the actual CT scan – and perform fast, automated geometry inspection tasks in combination with evaluation templates.
- > Import textured meshes and colored point clouds for a more meaningful documentation and visual analysis of objects.

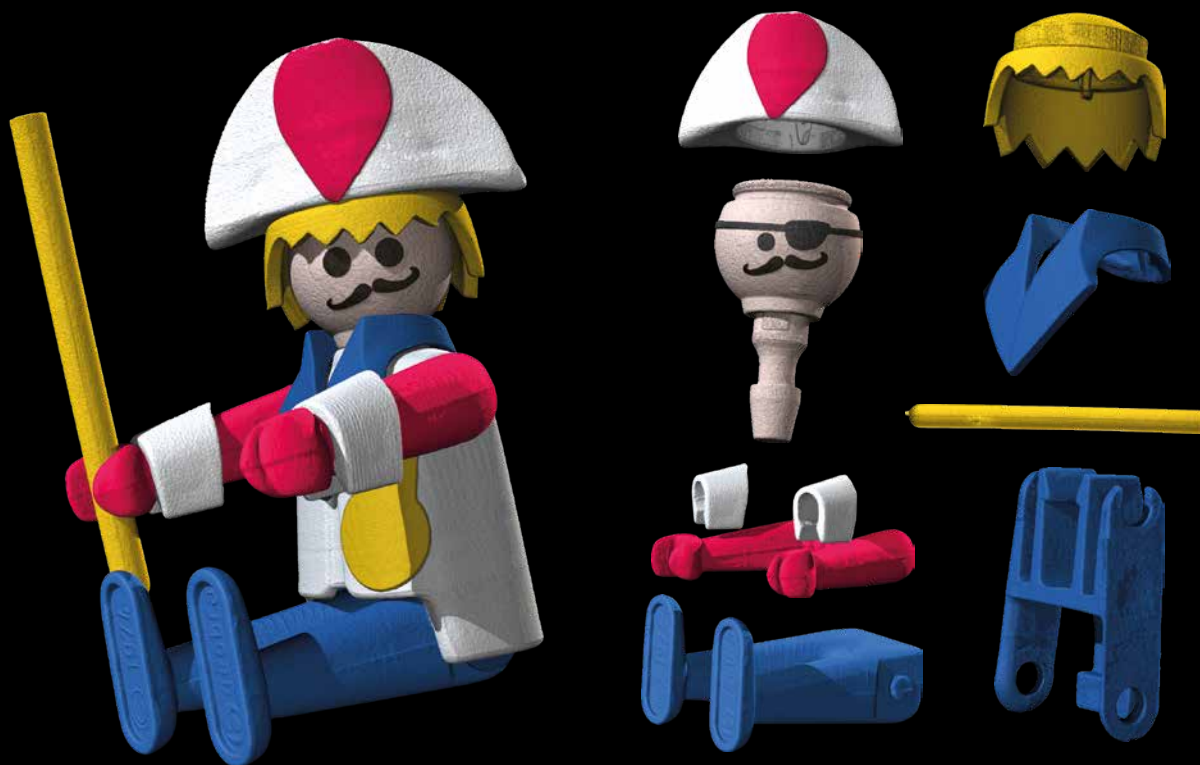

Exploded view of a plastic toy

Mathematical Calculations on Voxel Data

- > **Add, subtract, and average voxel data sets.**
- > Combine data sets that, e.g., have been scanned using different techniques into one meaningful data set.
- > Create a “golden” surface from the mean value of several scans.

Animation Options

- > **Create high-quality renderings.**
- > The object exploder animates exploded views of segmented objects.
- > In movies, see the exact position of the respective slice within the 3D model picture in picture.

Segmentation Tools

- > **Separate data sets into individual parts (Regions of Interest, or ROIs) that may consist of different components, materials, etc. using manual selection and drawing tools as well as semi-automated tools.**
- > Use subvoxel-precise segmentation to further increase accuracy.
- > Use CAD models as a starting contour for a (locally) adaptive surface determination and easily generate precise surfaces, especially in multi-material scenarios.*
- > Create ROIs from clipping objects.
- > Restrict analyses and visualizations to individual ROIs.
- > Use the drawing tool with upper and lower threshold values to easily separate even data sets with fluctuating gray values.
- > Specifically analyze near-surface properties with the enveloping ROI.

* Requires the Coordinate Measurement Module.

Documentation and Export

> Export images (color-coded in 3D and 2D), histograms, and data tables in common file formats to work with them in other applications.

- > Export all results in a standardized folder and file structure.
- > Create comprehensive and completely customizable test reports hand-in-hand with Microsoft Excel (requires Microsoft Excel).
- > See the exact position of the respective slice within the 3D model picture in picture when saving slice images.
- > Generate reports on all analyses linked to an object.
- > Define rules with which VGSTUDIO MAX generates images or annotations, e.g., to generate pictures of all defects exceeding a certain size.

Macros and Templates

> Automate the analysis of single data sets or a group of data sets with macros and templates.

- > Combine macros like building blocks in various contexts and constellations.
- > Use macros, templates, and jobs created in VGSTUDIO MAX for automation with VGINLINE.

Evaluations

> Save comprehensive inspection plans as evaluations to inspect parts semi- or fully automatically.

- > Connect the results of diverse analyses in order to achieve conclusive pass/fail decisions.
- > Use evaluations generated with VGSTUDIO MAX for serial inspection in VGINLINE.

Combined Analyses

> Combine the results of successive analyses.

- > Combine, e.g., a wall thickness analysis with a porosity/inclusion analysis to classify a defect according to its size in relation to the local wall thickness.

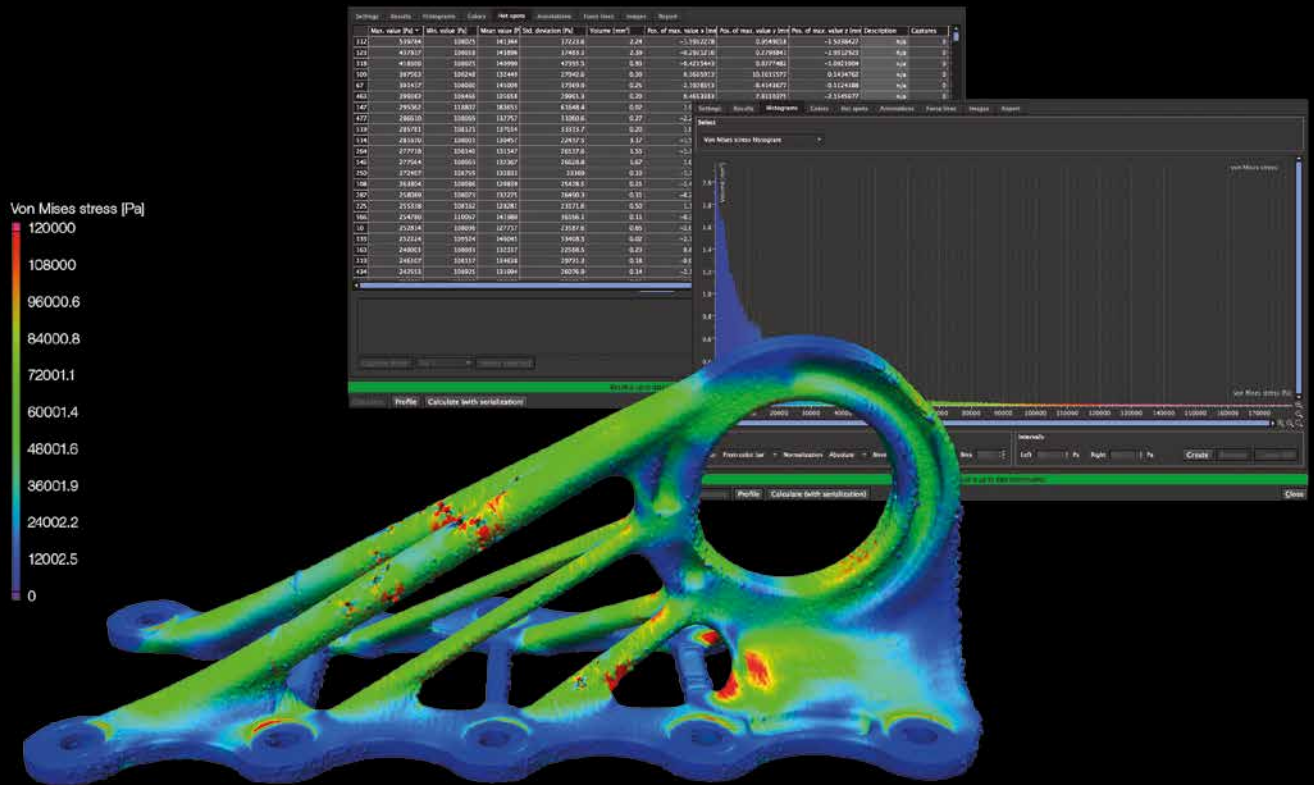

Add-on Modules

VGSTUDIO MAX offers an add-on module for nearly every application you can think of.

Structural Mechanics Simulation Module

> Performs virtual stress tests on your scanned part and helps you assess the impact of discontinuities on the part's stability

- > Identifies the most likely locations of failure with the automatic hotspot analysis
- > Works directly on voxel data and eliminates meshing as a source of error
- > Supports three types of static loads: directed force, torque, and pressure
- > Calculates and visualizes force lines, local displacements, and failure-related variables such as von Mises stress or the absolute maximum principal stress

- > Simulates both the actual part with all its discontinuities and shape deviations as well as the CAD model, allowing comparisons between the two
- > Is easy to use
- > Works even on highly complex structures such as foams or other porous media
- > Suitable for components or probes made from one or multiple linear-elastic materials
- > Fast distributable computing on up to 16 network computers (requires Structural Mechanics Cluster Extension)

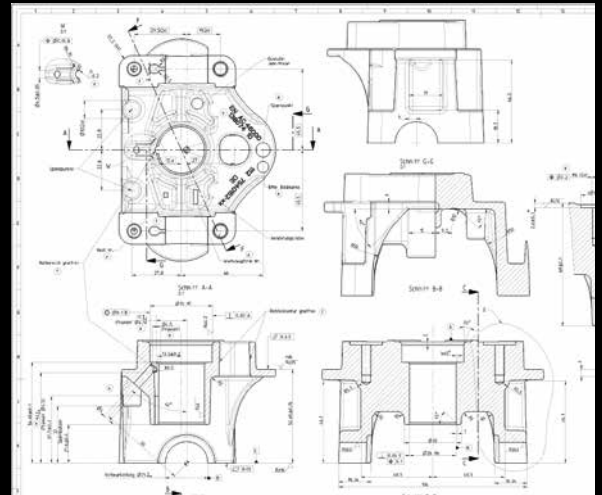
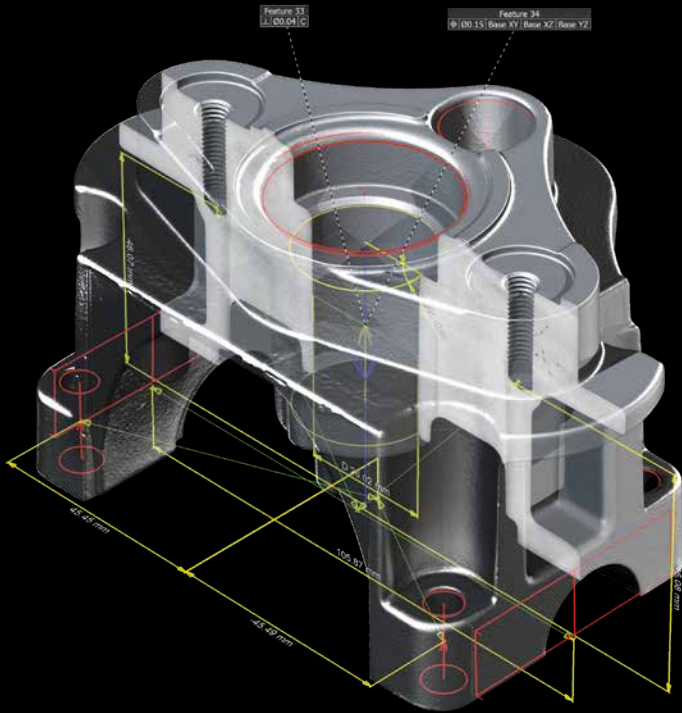

Easily apply a conventional measurement plan to your voxel data.

Coordinate Measurement Module

> Measures even the most difficult-to-access surfaces of a component

- > Measurements on voxel, point cloud, mesh, and CAD data
- > GD&T functionality (based on DIN EN ISO 1101)
- > Geometry element fitting optimized for voxel, CAD, and mesh data
- > Registration with boundary conditions, e.g., rotation of an object around one axis only while locking the others
- > Alignment techniques, e.g., 3-2-1 registration that allows for offsets and subsequent rotations for solving highly complex alignment tasks
- > Feature-based registration mode that aligns a scan which only covers a section of a sample to, e.g., the CAD model of the entire part

- > Tolerancing of registration results to determine their quality
- > Automatic selection of the type of geometry element to be fitted
- > Automated generation of datum systems
- > Creation of common datums
- > Line and surface profile tolerances
- > Construction with geometry elements
- > Extraction of min./max. fit points
- > Reduction of measurement uncertainty due to thousands of automatically generated fit points
- > Preparing of inspection plans on CAD data, CT scan or mesh data
- > Saving of compact .mvgl files for VGMETROLOGY ES

The Volume Graphics Metrology Kernel in VGSTUDIO MAX (Windows 64 bit) has been verified by the Physikalisch-Technische Bundesanstalt (PTB), Germany's national metrology institute.*

* PTB tested the algorithms based on the minimum-zone method ("Chebyshev") and the least-squares method ("Gauss"). These algorithms are used for coordinate measurement in VGSTUDIO MAX.

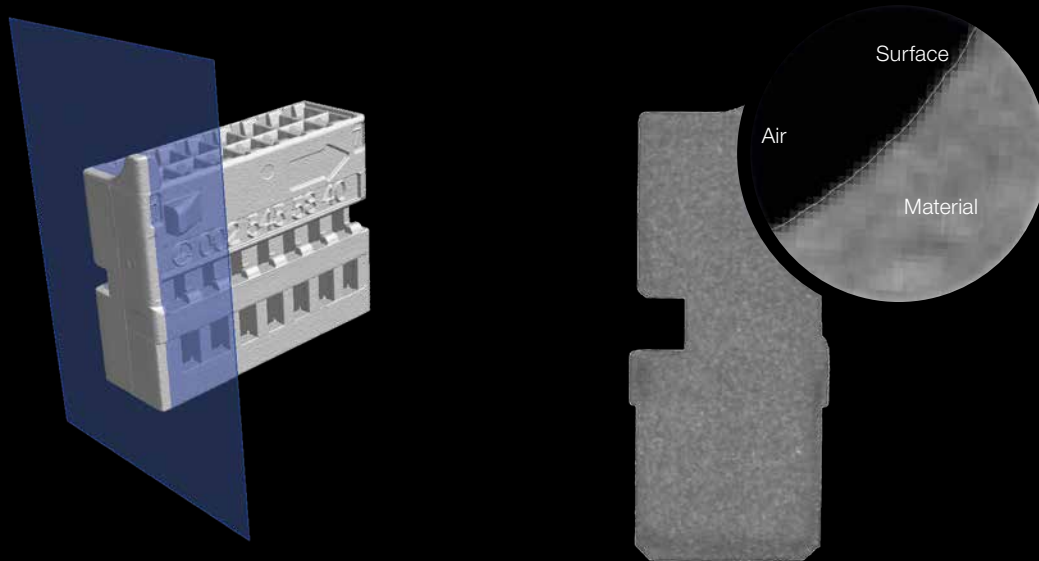

Between material and air is the surface. Often the surface is defined by a single gray value. When using Advanced Surface Determination, however, the gray values are processed depending on the gray values of the surrounding voxels. The result is a much more precise surface.

Advanced Surface Determination

Part of the Coordinate Measurement Module

> **Subvoxel-precise surface determination makes even those details visible that are smaller than a voxel – automatically, manually, and interval-based.**

- > Gray values of individual voxels are processed depending on the gray values of the surrounding voxels, which makes the surface determination markedly more precise.
- > The interval-based mode allows for a high-precision, locally adaptive surface determination, even within an automated environment and with changing gray value conditions.

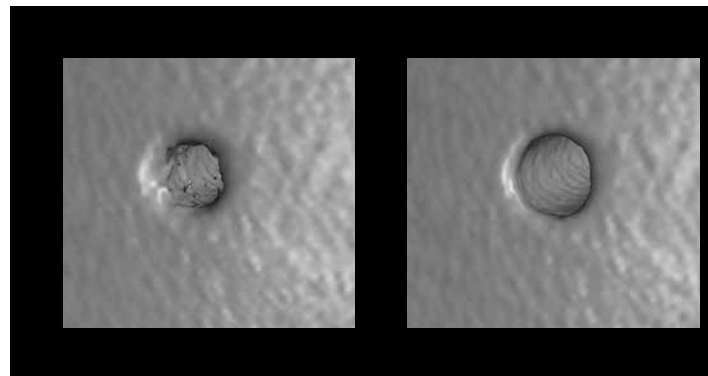

Not just smoother but also more precise: Using the subvoxel-precise surface determination (right) reduces your measurement uncertainty by giving you details the voxel-based surface determination (left) is not able to show.

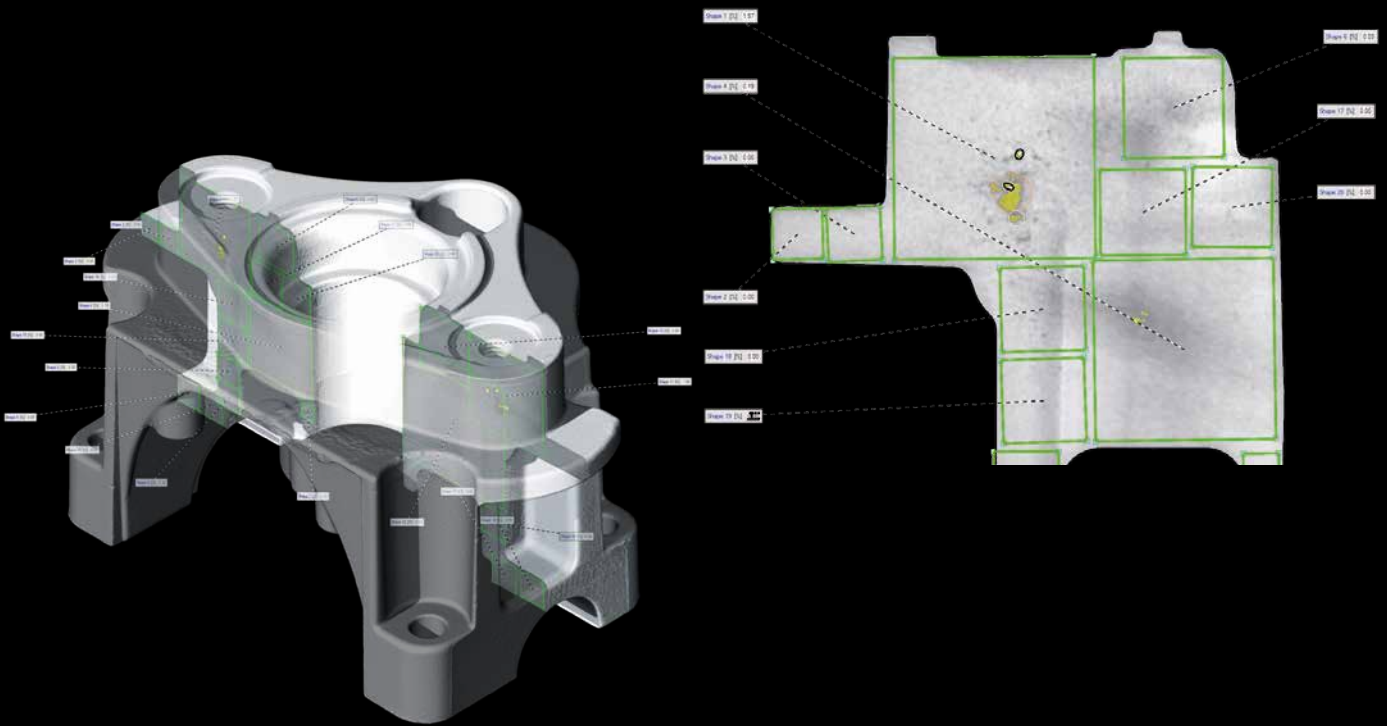

2D analysis according to P 202/P 201 directly in the CT data



Enhanced Porosity/Inclusion Analysis Module

> Supports defect analyses in accordance with the VDG rules P 202 (VW 50093) and P 201 (VW 50097)

- > Eliminates the need for the time-consuming production of micrograph sections and the preparation of samples in many cases
- > Quantifies the surface size of defects in CT slice images automatically
- > Supports templates to rapidly and repeatedly analyze all parts without manual intervention
- > Includes local adaptive mode for improved pore detection

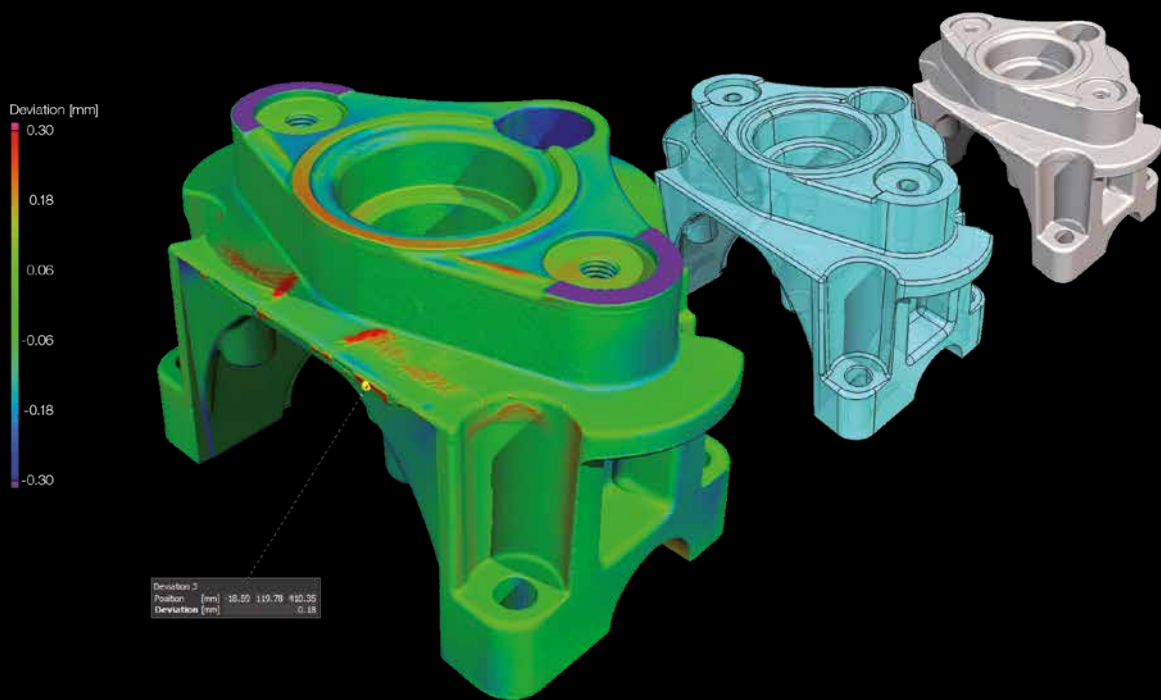

Compare your scanned object with its respective CAD data set. Get color-coded results of deviations and local annotations.

Nominal/Actual Comparison Module

> **Allows for a geometric comparison of voxel, mesh, and CAD data**

> Application of tolerances to the nominal/actual comparison with various parameters, e.g., deviation (minimum, maximum, cumulated)

Note: Requires the Coordinate Measurement Module

Wall Thickness Analysis Module

> **Automatically and quickly analyzes wall thicknesses**

- > Works for near parallel surfaces (ray method) as well as for curved or branching surfaces (sphere method), including complex 3D printed shapes
- > Localizes areas with an insufficient or excessive wall thickness or gap width automatically and directly within the voxel, point cloud, mesh, or CAD data set
- > Allows the application of tolerances with various parameters, e.g., thickness (minimum, maximum, mean, deviation)
- > Reduces the number of false detections with a noise filter, which is especially helpful for automated inspections

Note: Recommended to order in combination with Coordinate Measurement Module.

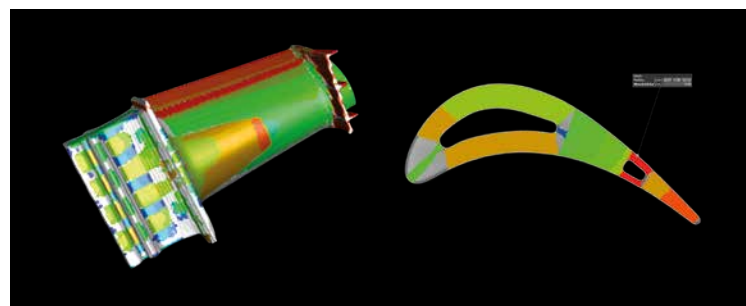

Color-coded results of a wall thickness analysis

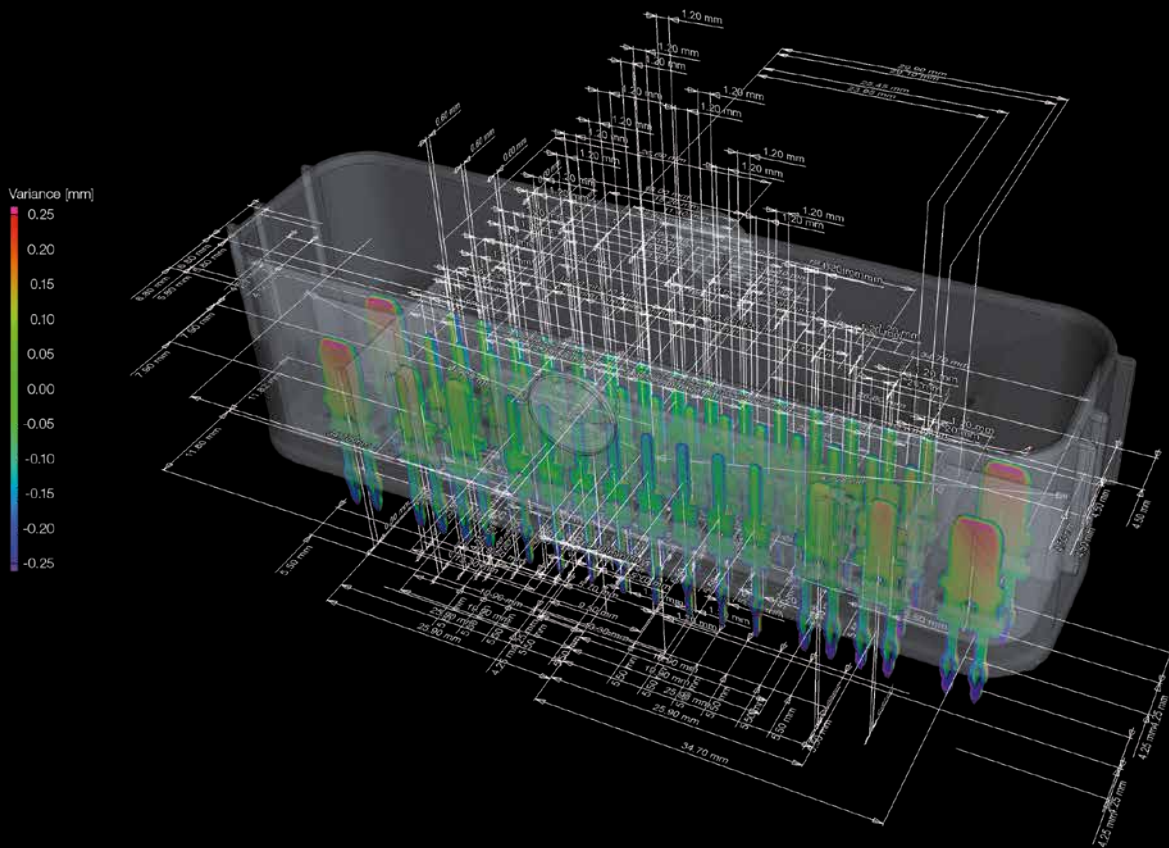

With the corresponding add-on module, VGSTUDIO MAX understands additional information stored in PMI data.



CAD Import Module*

- > **Uses native CAD files such as CATIA V5 and Creo/Pro/ENGINEER for nominal/actual comparisons, segmentation, and other tasks (in addition to the STEP and IGES formats in the basic edition of VGSTUDIO MAX)****
- > Offers enhanced auto-completion modes
- > Replaces CAD geometries with matching geometry elements
- > Automatically translates CAD views into bookmarks

CAD Import with PMI*

- > **Understands so-called Product and Manufacturing Information (PMI) that is generated in many current CAD systems and provides additional part information, e.g., dimensioning, GD&T, layers, annotations, or captions*****
- > Saves a considerable amount of time when preparing measurement plans and thus increases the efficiency of your quality control by intelligently evaluating PMI data
- > Comes with all features of the CAD Import Module

* CAD translation technology supplied by Tech Soft 3D.

** Supported CAD formats are: CATIA V5 (up to V5-6 R2018), Creo (up to 5.0 Beta). In beta status: CATIA V4 (up to 4.2.5), JT (up to 10.0), Pro/ENGINEER (up to 19.0), Unigraphics/NX (V11.0 to NX 12.0), Solid Edge (V19 – 20, ST – ST10), SolidWorks (from 97 up to 2018).

*** PMI import is supported for CATIA V5 and Creo. In beta status also for Pro/ENGINEER and Unigraphics/NX.

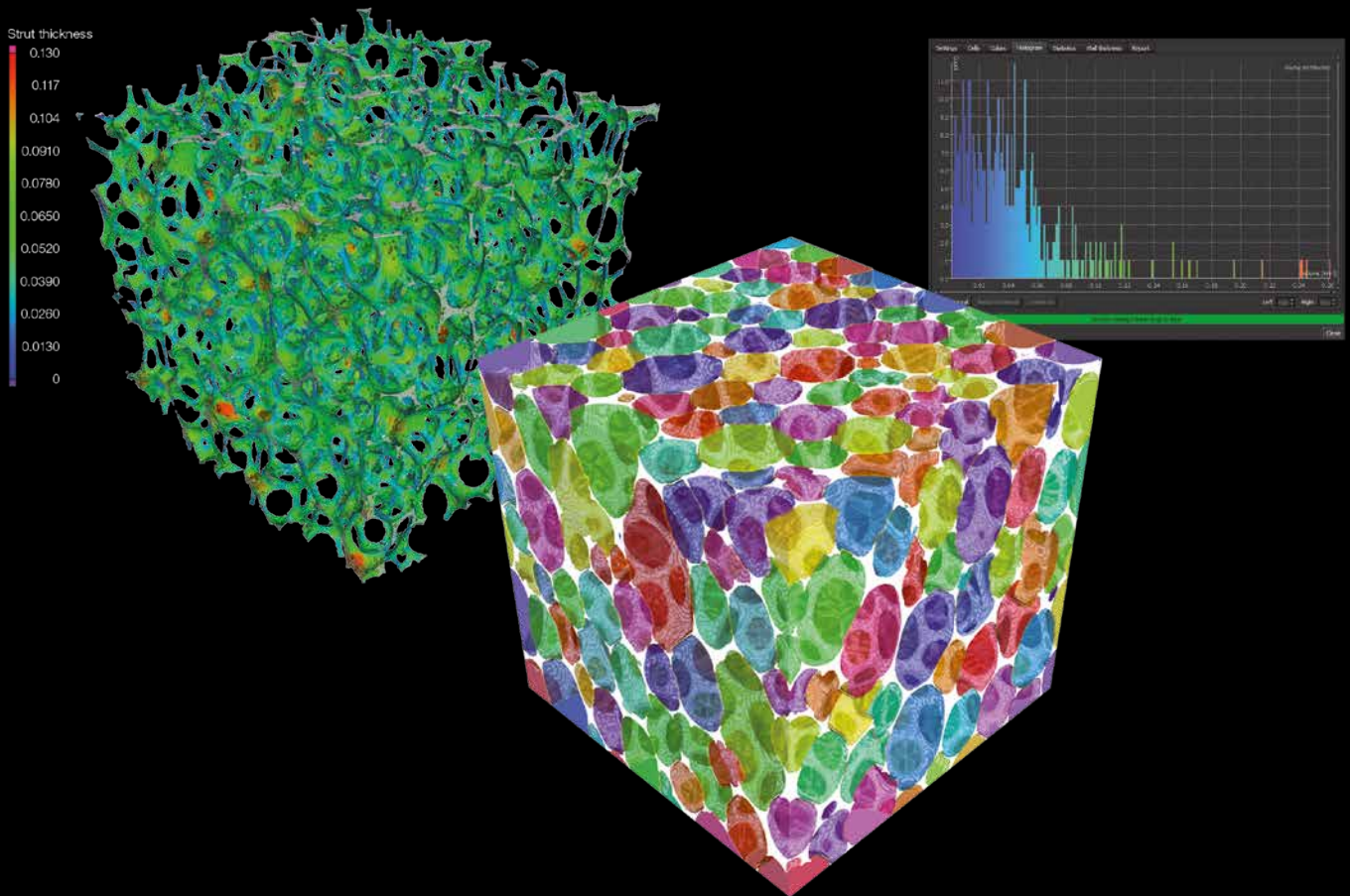

Visualize foam or foam-like structures and calculate properties.



Foam Structure Analysis Module

> Determine cell structures in porous foams and filter materials.

- > For example:
 - Cell volume, surface, and sphericity
 - Contact surfaces
 - Average strut thickness
 - Euler numbers and characteristics
 - Average and total curvature and many more
- > View your results color-coded, as a histogram, or as a table.
- > Use active columns to switch easily between different parameters.
- > Exclude boarder area to limit unwanted side effects.

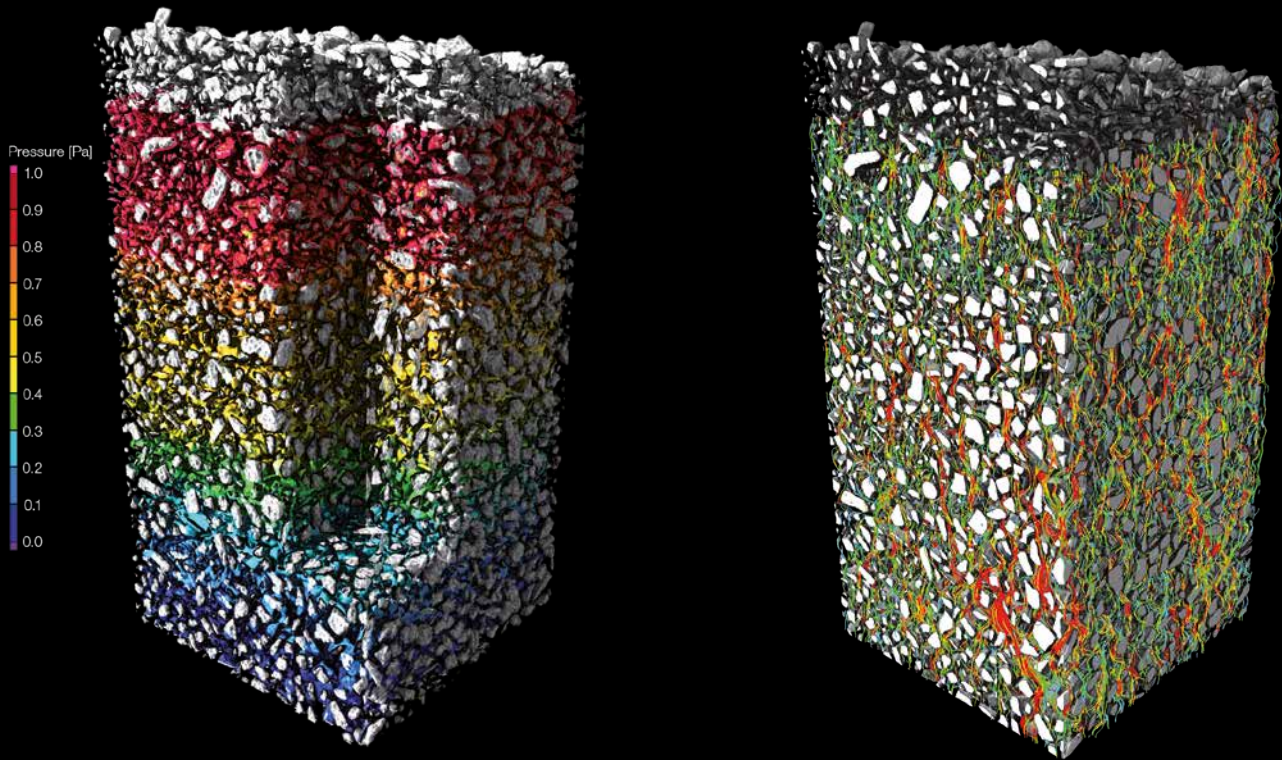

Color-coded visualization of transport phenomena, left: pressure, right: streamline view



Transport Phenomena Module

- > **Perform microstructure level virtual flow and diffusion experiments directly on CT scans of porous and multi-component materials – no meshing required.**
- > Calculate homogenized material properties such as absolute permeability, tortuosity, formation factor, molecular diffusivity, electrical resistivity, thermal conductivity, or porosity.
- > Calculate tensor-valued material properties for anisotropic samples.
- > Stop and re-start the calculation at any time to inspect intermediate results.
- > Use microstructure level simulation results in large-scale simulations by enriching imported mesh cells in various formats (e.g., NASTRAN, PATRAN) with homogenized material properties determined with VGSTUDIO MAX and use these enriched mesh cells in third-party simulation software.
- > Use one or more GPUs to speed up calculations thanks to OpenCL.

Capillary Pressure Module

Part of the Transport Phenomena Module

- > **Provides quantities that are used, e.g., in geosciences to characterize soil and rock samples**
- > Computes the pore size distribution and the capillary pressure drainage curve for a scanned porous material
- > Performs virtual MICP (mercury injection capillary pressure) experiments

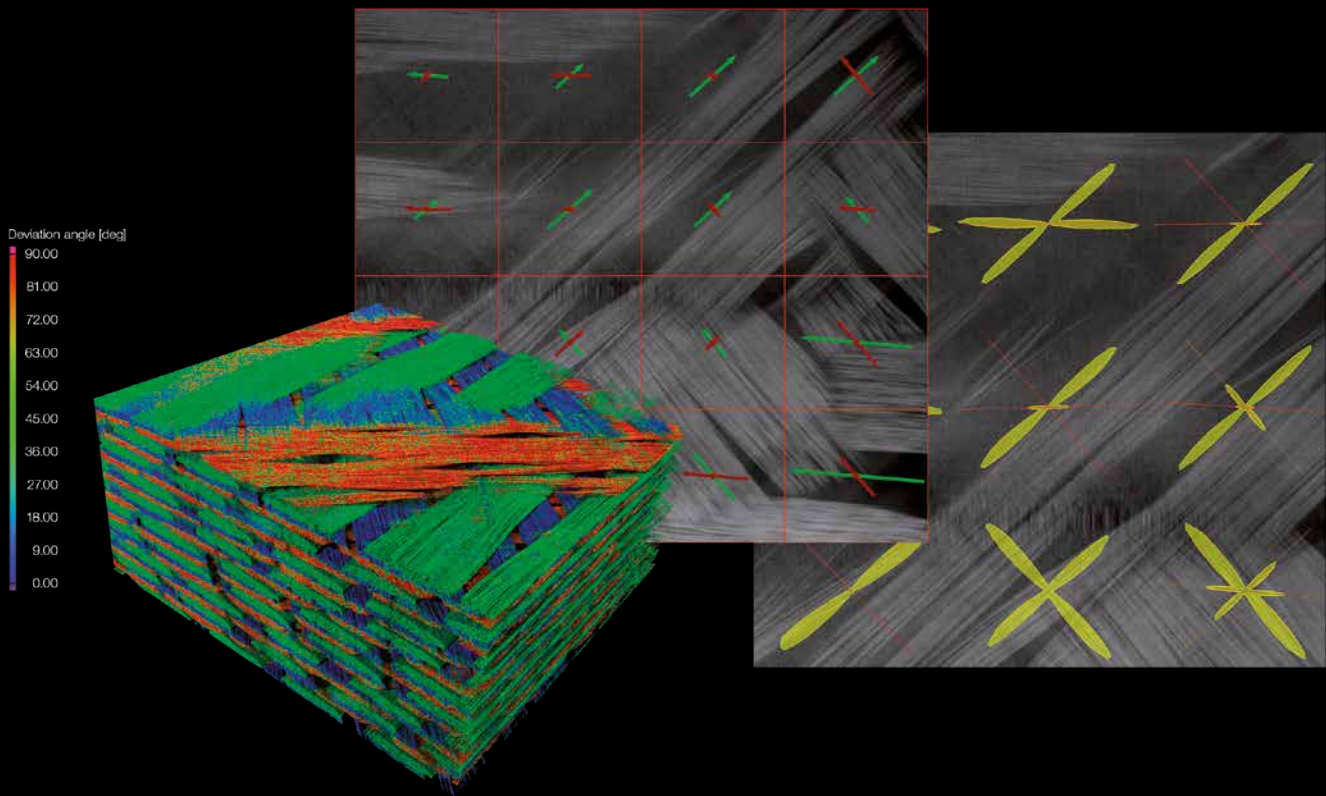

Analyze fiber composites, color-code different fiber orientations, see main directions, and display orientation distributions.

Fiber Composite Material Analysis Module

> Gain insights into fiber composite materials such as carbon-fiber-reinforced plastic (CFRP) or glass-reinforced plastic (GRP).

- > Calculate, e.g., local fiber orientations, local fiber volume fractions, global fiber orientation distributions, and global volume fractions.
- > Display local fiber orientation in color code or as vectors or tensors.
- > View the detailed angular distribution of any number of directions in a 2D histogram.
- > Determine the main orientations for fabrics or rovings.
- > Display global orientation distribution, e.g., as a histogram.
- > Produce line plots of the individual components of the orientation tensor in order to easily compare nominal and actual values.
- > Import meshes thanks to the support of PATRAN and NASTRAN files.
- > Export analyzed material properties for use in your simulation software.

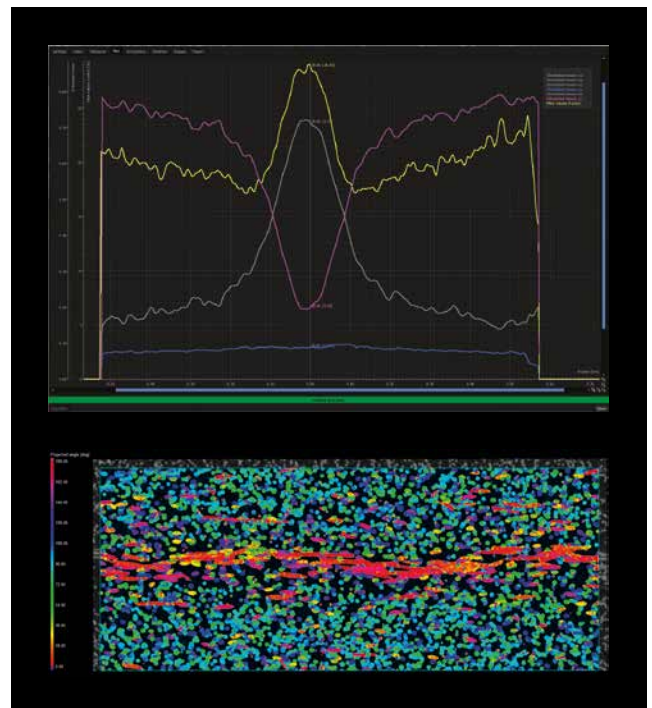

Top: Orientation tensor for the three main directions. The horizontal axis indicates the horizontal position (in the plate).
Bottom: Corresponding slice selection.

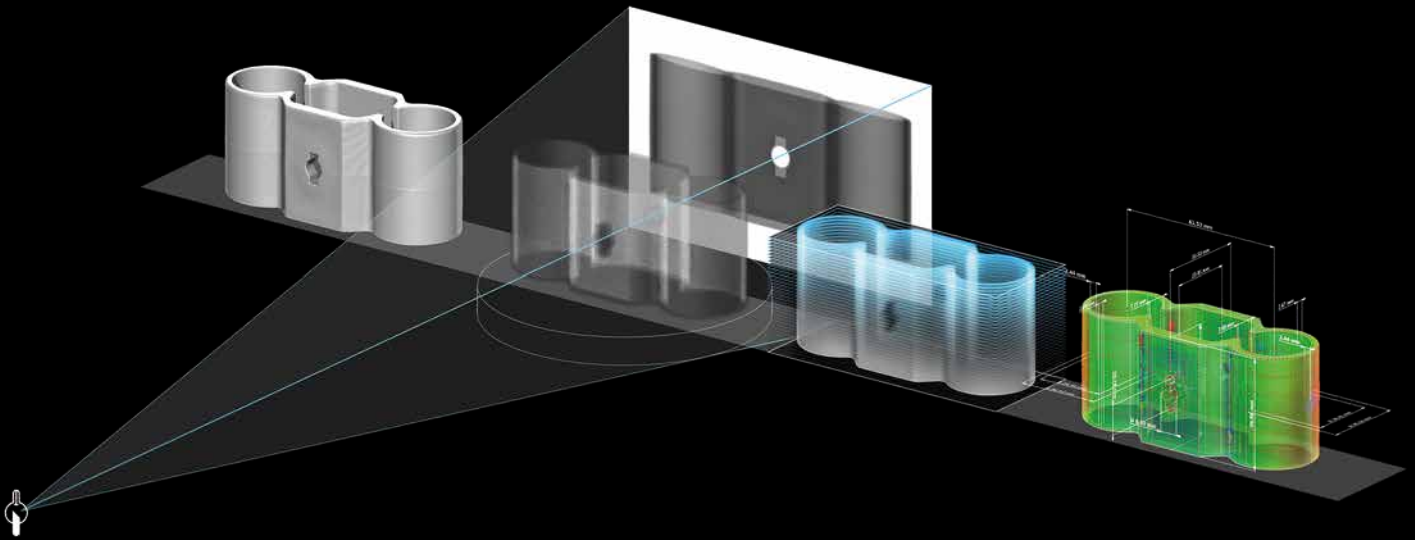

The CT Reconstruction Module seamlessly fits into your daily workflow.



CT Reconstruction Module

> **Quickly and precisely calculates 3D volume data sets from the images taken by a CT scanner, which can then be analyzed and visualized in VGSTUDIO MAX**

- > Supports cone beam, fan beam, parallel beam, planar, and helical (spiral) CT
- > Reconstruction of large parts by using measuring circuit extensions
- > Features robust, automatic scan geometry corrections (e.g., detector shift and rotation axis tilt)
- > Supports Feldkamp, Davis, and Kress (FDK) and Algebraic Reconstruction Technique (ART) for image reconstruction
- > Improves the image quality using the standard Volume Graphics beam hardening correction or the optional Iterative Artifact Reduction (IAR) *
- > Reduces metal and ring artifacts
- > Provides previews for faster evaluation of CT measurements
- > Uses one or multiple GPUs to speed up calculations by incorporating OpenCL
- > Supports automatic parameter import of many CT systems

* Technology licensed by Fraunhofer EZRT

Licenses and Bundles

Licensing Options

- > Four license models: node-locked, floating, global floating, or dongle license
- > Six languages: English, German, French, Japanese, Chinese, and Korean
- > Free evaluation license with full functionality: www.volumegraphics.com/evaluation
- > Optional update/service agreement for access to regular product updates and priority support
- > Individually combinable add-on modules for tailoring VGSTUDIO MAX to your needs

Software Bundles

- > Preconfigured for the most common tasks within various industries
- > Considerable savings in comparison to buying modules separately
- > Including an update/service agreement that will keep the software up to date up to one year after the date of purchase

Bundles		Geometry	Material	Cast & Mold
Includes		For metrology and quality control in a variety of industries	For lightweight construction in a variety of industries, e.g., aerospace	For the automotive industry, aerospace industry, medical engineering
	Coordinate Measurement Module	✓	✓	✓
	Nominal/Actual Comparison Module	✓		✓
	Wall Thickness Analysis Module	✓		✓
	Porosity/Inclusion Analysis Module		✓	✓
	Enhanced Porosity/Inclusion Analysis Module			
	Fiber Composite Material Analysis Module		✓	
	Transport Phenomena Module			
	Foam Structure Analysis Module		✓	
	Structural Mechanics Simulation Module			

System Requirements

Please visit our website to read about the latest system requirements for VGSTUDIO MAX:
www.volumegraphics.com/requirements



Cast & Mold Enhanced	Composites & Plastic	Oil & Gas	Complete *
For aluminum casting, mainly for the automotive industry	For industries working with plastic injection molding and fiber composite materials	For the oil and gas industry, construction industry, filter manufacturers, and geologists	For advanced users in quality assurance labs who face different analysis and measurement tasks as part of their daily work
✓	✓	✓	✓
✓	✓		✓
✓	✓		✓
✓	✓	✓	✓
✓			✓
	✓		✓
		✓	✓
		✓	✓
			✓

* Does not include the add-on modules CT Reconstruction, CAD Import, CAD Import with PMI, Structural Mechanics Cluster Extension

Software for Industrial CT

Volume Graphics' range of products – comprising VGSTUDIO MAX, VGSTUDIO, VGMETROLOGY, VGinLINE, and myVGL – allows all types of analyses and visualizations directly on industrial computed tomography (CT) data. With Volume Graphics software, there is no need to convert voxel data into other formats. The ability to display and analyze both voxel and polygon data within one application makes Volume Graphics software unique.

Other Solutions



VGinLINE
Integrated solution for
production workflows

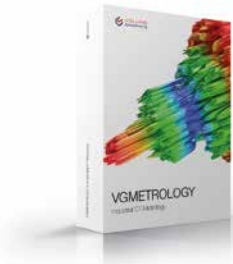

VGMETROLOGY
Easy-to-use, universal
metrology solution



VGSTUDIO
Entry into the world of CT data
analysis and visualization



myVGL
Universal volume data viewer (free)



VG Academy

Training Information

VG Academy has one goal: to enable you to better solve your inspection tasks with our products. As your partner for training courses and workshops for all Volume Graphics software products, we help you to work more confidently and efficiently with your VG software. Simply sign up for one of our various training courses!

All courses are available in German and English. Please contact us if you require training in other languages such as Chinese, French, Italian, Japanese, Korean, or Russian.

Training Locations

- > VG Academy at Volume Graphics Headquarters in Heidelberg, Germany
- > VG Academy in Charlotte, NC, USA; Nagoya, Japan; and Beijing, China
- > On-site at your office

Training Options

- > Basic and Focus training courses for VGSTUDIO MAX
- > Introductory VGMETROLOGY training
- > VGMETROLOGY VIEWER training
- > Boot Camps and individual workshops
- > Train-the-Trainer (for VG partners)
- > ... and much more

How to Sign Up

If you wish to participate in a training course or if you have any further questions, please contact us via e-mail at academy@volumegraphics.com or by phone +49 6221 73920-810. The interactive training consultant on our website is also an excellent resource for finding a course that's right for you.



**VOLUME
GRAPHICS**

Enabling better products

Headquarters

**Volume Graphics GmbH
Speyerer Straße 4–6
69115 Heidelberg, Germany**

Phone: +49 6221 73920-60

Fax: +49 6221 73920-88

sales@volumegraphics.com

www.volumegraphics.de

**Volume Graphics Co., Ltd.
1-3-19, Osugi, Kita-ku
Nagoya 462-0837, Japan**

Phone: +81 52-508-9682

Fax: +81 52-508-9689

sales@volumegraphics.jp

www.volumegraphics.jp

**Volume Graphics, Inc.
415 Minuet Lane, Suite C
Charlotte, NC 28217, USA**

Phone: +1 704 248 7736

Fax: +1 704 248 0558

sales-us@volumegraphics.com

www.volumegraphics.com

**Volume Graphics (Beijing) Technology Co., Ltd.
Unit D-01-0-1205 B, 12th floor, Building 5
No. 19 Dongfangdonglu
Chaoyang District, Beijing 100600, China**

Phone: +86 10 8532 6305

sales@volumegraphics.cn

www.volumegraphics.cn



© 2018 Volume Graphics GmbH, VGL is a registered trademark of Volume Graphics GmbH, Germany. All company, product, or service names mentioned in this brochure are used for identification purposes only and may be trademarks of their respective owners.

VG-198-EN-v01_B | 04.2018 | Modifications and errors reserved.